

# Cama Classic





## Notas Importantes

Coloque todas as peças numa superfície suave como uma carpete para evitar que alguma peça fique riscada

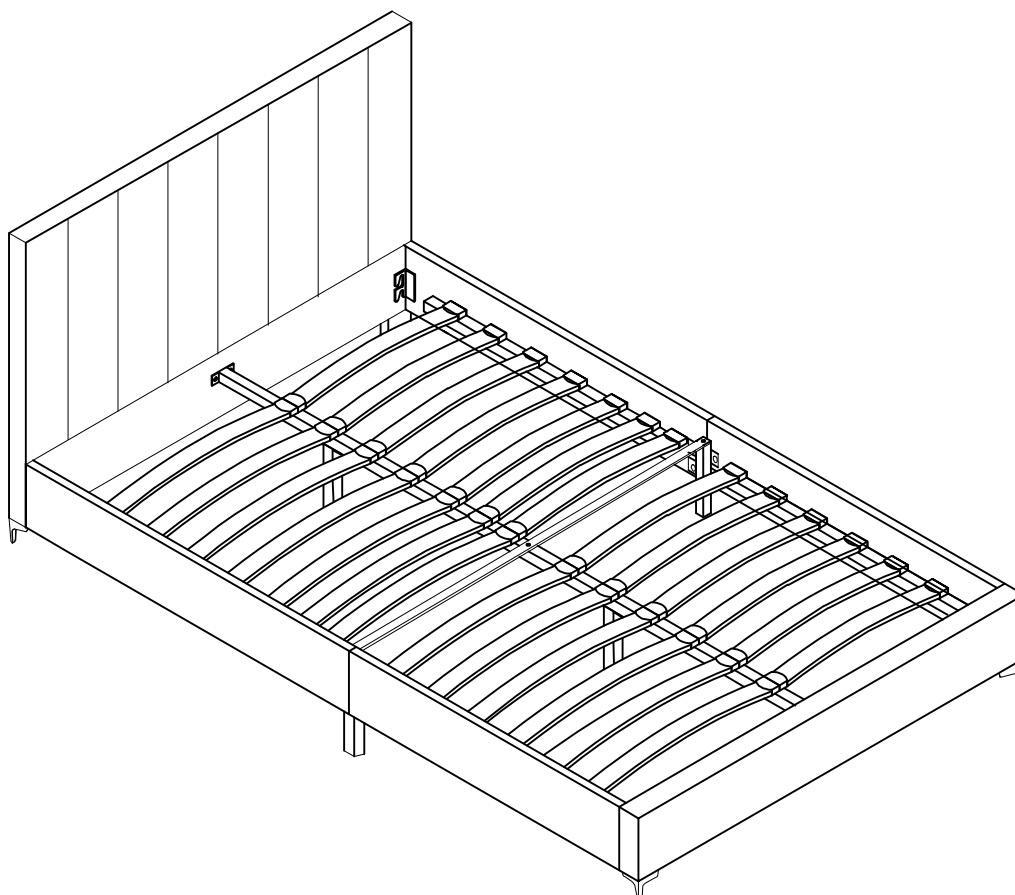

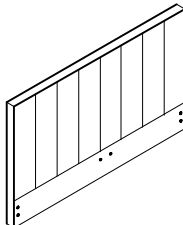
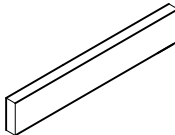
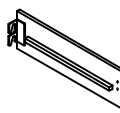
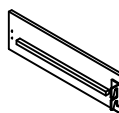
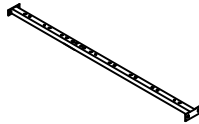
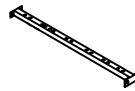

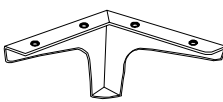
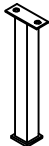
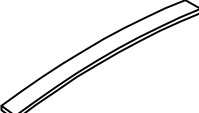

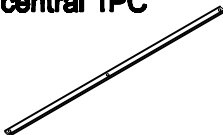



Antes de iniciar leia as instruções atentamente e siga-as passo a passo

Não aperte todos os parafusos até que a cama esteja completamente montada



<p>① - Cabeceira 1PC</p> 	<p>② - Tábua frontal 1PC</p> 	<p>③ - Tábua laterais 2PCs</p> 
<p>④ - Tábua laterais 2PCs</p> 	<p>⑤ - Barra de suporte central 1PC</p> 	<p>⑥ - Barra de suporte central 1PC</p> 
<p>⑦ - Siderails Support legs(2pcs)</p> 	<p>⑧ - Pés amovíveis 4PCs</p> 	<p>⑨ - Pés de apoio 2PCs</p> 
<p>⑩ - Tábuas de estrado 28PCs</p> 	<p>⑪ - Capa plástica dupla 14PCs</p> 	<p>⑫ - Capa plástica 28PCs</p> 
<p>⑬ Barra de suporte central 1PC</p> 		

# Identificação de peças

<p><b>A</b> Parafuso M8*30mm 20pcs</p> 	<p><b>B</b> Parafuso M8*50mm 1pc</p> 	<p><b>C</b> Chave em L M6 * 1pc</p> 	<p><b>D</b> Anilhas de mola 11pcs</p> 
<p><b>E</b> Anilhas M8*19mm 37pcs</p> 	<p><b>F</b> Chave em L M8 * 1pc</p> 	<p><b>G</b> Porca M8*13mm 7pcs</p> 	<p><b>H</b> Chave de bocas 1pc</p> 
<p><b>I</b> Parafuso M8*20mm 8pcs</p> 	<p><b>J</b> Parafuso M6*25mm 12pcs</p> 		

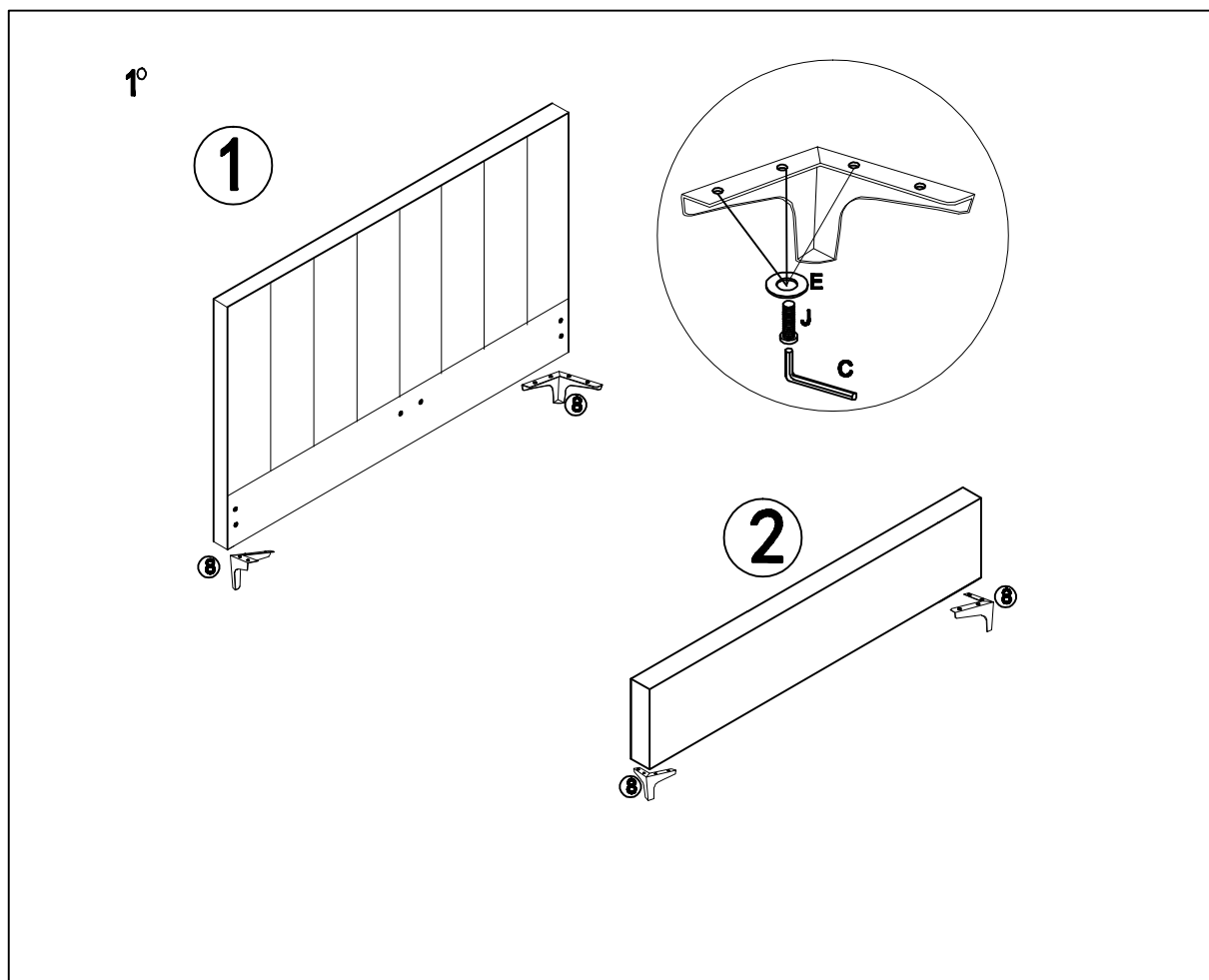

2°

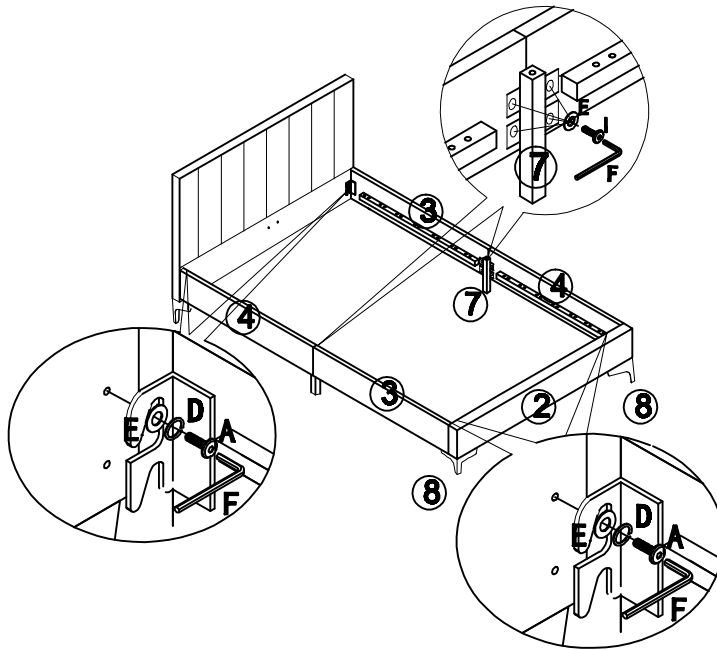

3°

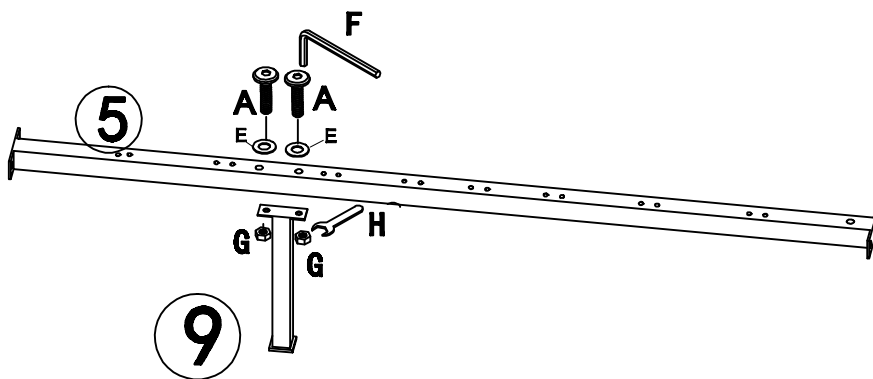

4°

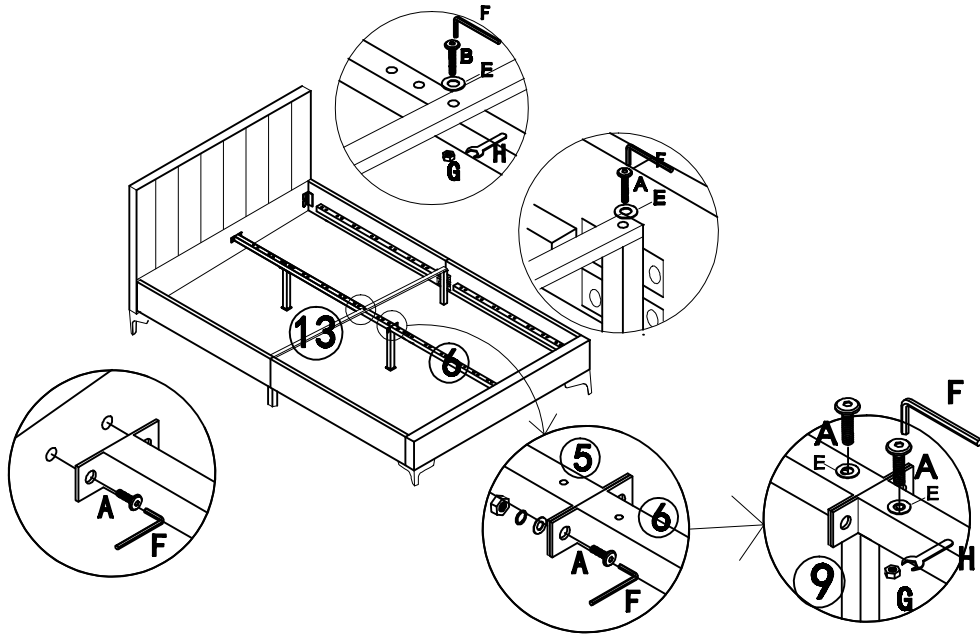

5°

FIM

