

Cama Love





Notas Importantes

Coloque todas as peças numa superfície suave como uma carpete para evitar que alguma peça fique riscada

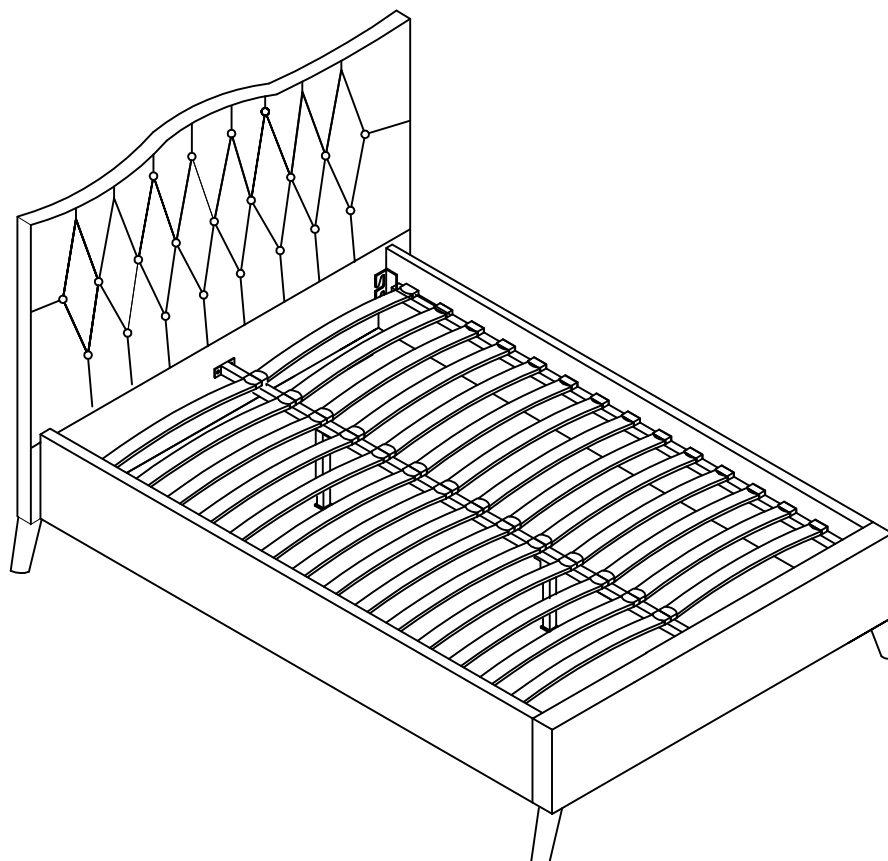

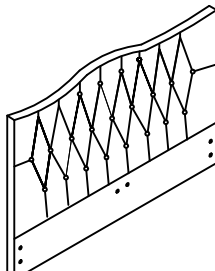
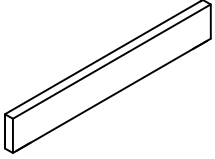
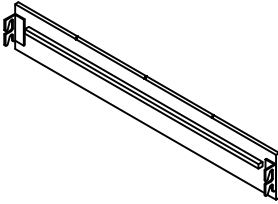
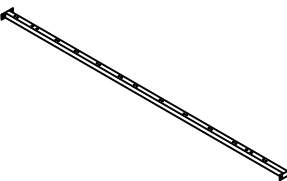

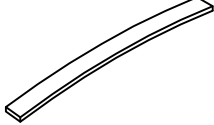
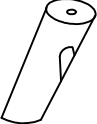
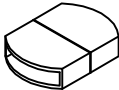

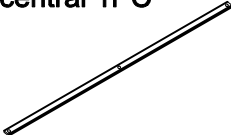
Antes de iniciar leia as instruções atentamente e siga-as passo a passo

Não aperte todos os parafusos até que a cama esteja completamente montada



<p>① - Cabeceira 1PC</p> 	<p>② - Tábua frontal 1PC</p> 	<p>③ - Tábua laterais 2PCs</p> 
<p>④ - Barra de suporte central 1PC</p> 	<p>⑤ - Pés de apoio 2PCs</p> 	<p>⑥ - Tábuas de estrado 30PCs</p> 
<p>⑦ - Pés amovíveis 4PCs</p> 	<p>⑧ - Capa plástica dupla 15PCs</p> 	<p>⑨ - Capa plástica 30PCs</p> 
<p>⑩ Barra de suporte central 1PC</p> 		

Identificação de peças

<p>Ⓐ Parafuso M8*35mm 14pcs</p> 	<p>Ⓑ Porca M8*13mm 3pcs</p> 	<p>Ⓒ Anilhas de mola 8pcs</p> 	<p>Ⓓ Anilhas 17pcs</p> 
<p>Ⓔ Chave em L 1pc M5</p> 	<p>Ⓕ Chave de bocas 1pc</p> 	<p>Ⓖ Parafuso M8*45mm 7pcs</p> 	

1º Passo Fixar os pés à cabeceira e à tábua frontal

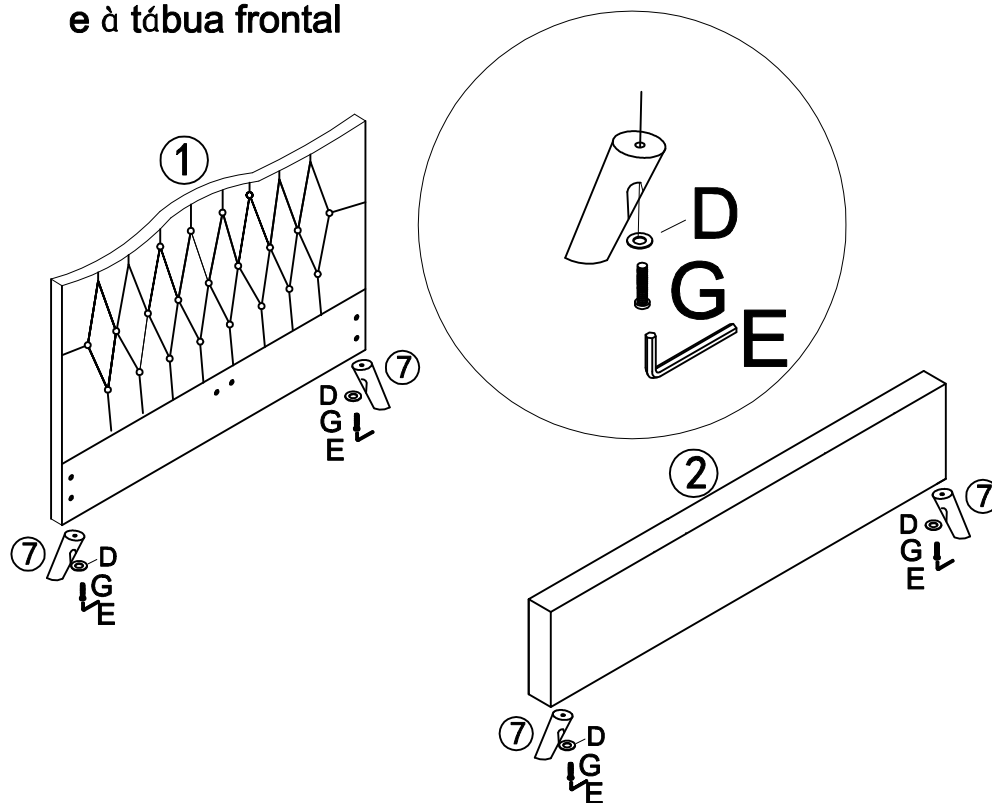

2º Passo Fixar os pés de apoio à barra de suporte central

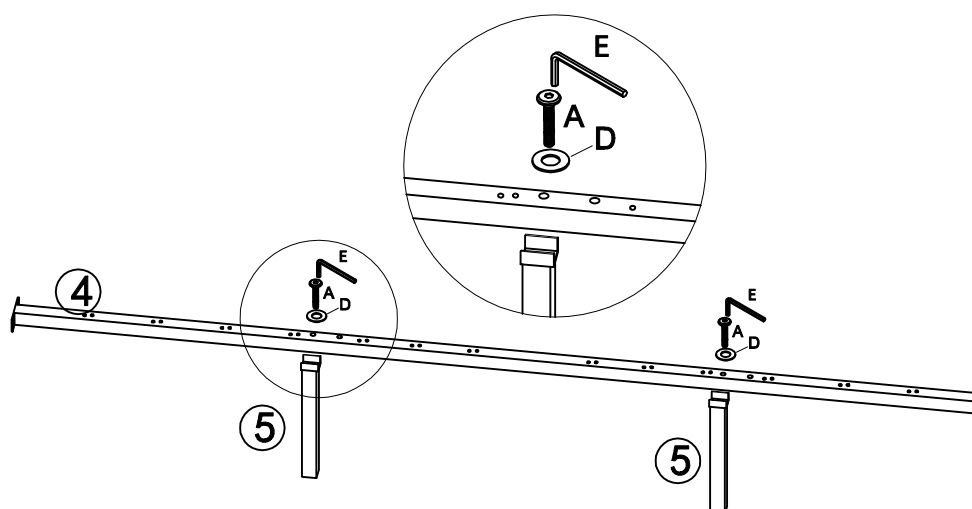

3º Passo Fixar as tábuas laterais à cabeceira e as tábuas laterais à tábua frontal

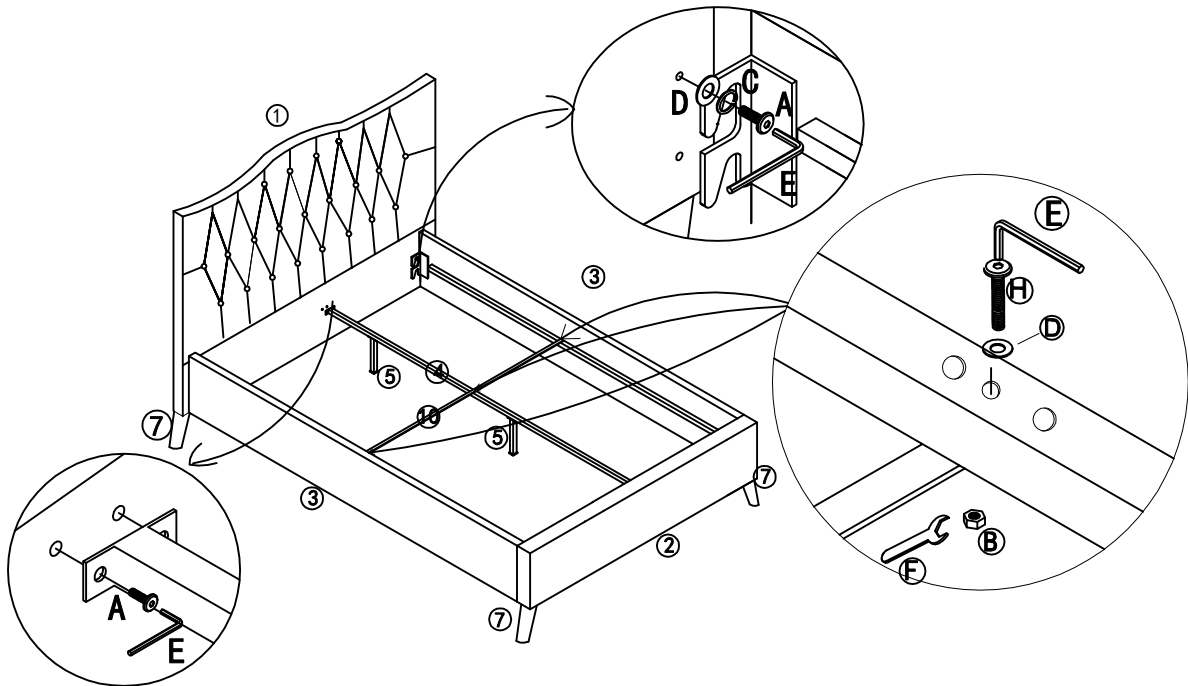

4º Passo Fixar barra de suporte central à cabeceira e à tábua frontal

Passo Fixar as capas de plástico e as tábuas de estrado

FIM

