

# Cama Paris

## Notas Importantes

Coloque todas as peças numa superfície suave como uma carpete para evitar que alguma peça fique riscada

Antes de iniciar leia as instruções atentamente e siga-as passo a passo

Não aperte todos os parafusos até que a cama esteja completamente montada

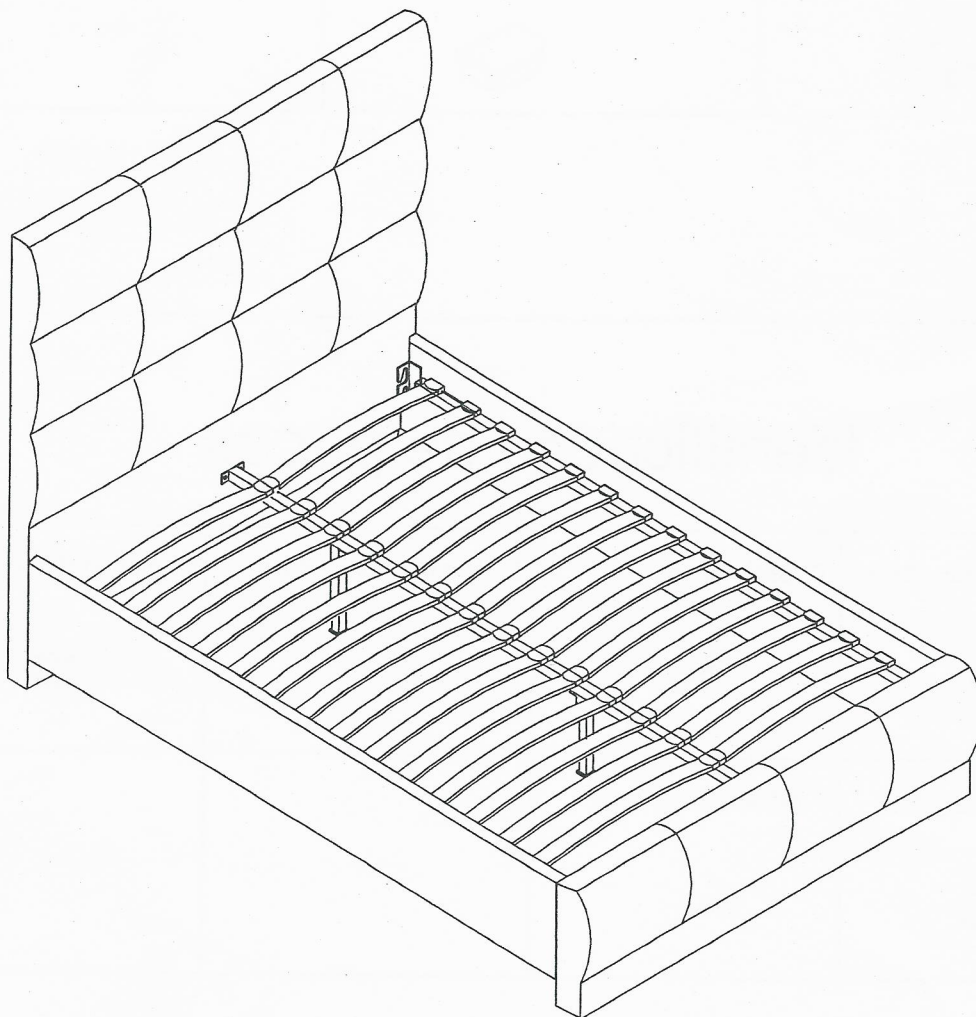

① - Cabeceira 1PC

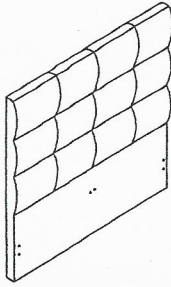

② - Tábua frontal 1PC

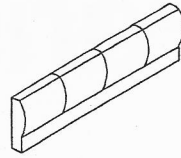

③ - Tábua laterais 2PCs

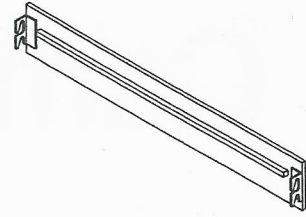

④ - Barra de suporte central 1PCS

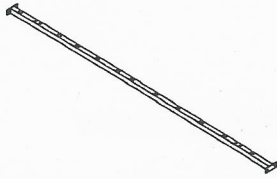

⑤ - Pés de apoio 2PCs



⑥ - Tábuas de estrado 26PCs

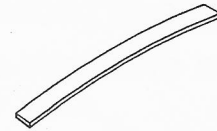



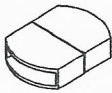



⑦ - Capa plástica dupla 13PCs



⑧ - Capa plástica 26PCs



## Identificação de peças

A Bolt M8*30mm 16pcs 	B Spanner 1pc 	C Nut M8*13mm 4pcs 	D Spring Washer 8pcs 
E Flat Washer 8pcs 	F M8 Allen Key 1pc 		

1º Passo Fixar os pés de apoio à barra de suporte central

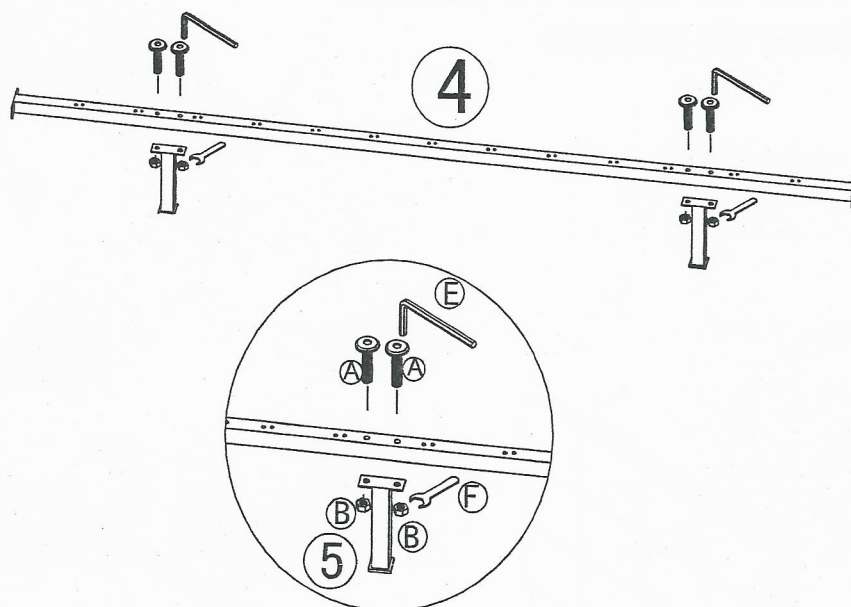

2º Passo Fixar as tábuas laterais à cabeceira e as tábuas laterais à tábua frontal

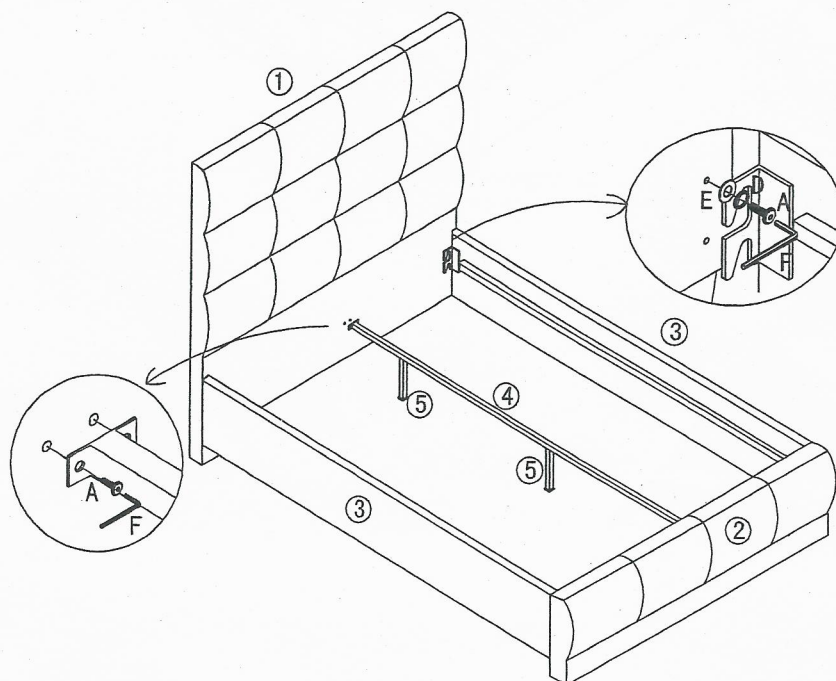

### 3 Passo Fixar barra de suporte central à cabeceira e à tábua frontal

- Passo Fixar as capas de plástico  
e as tábuas de estrado

FIM

