

Cama Doris







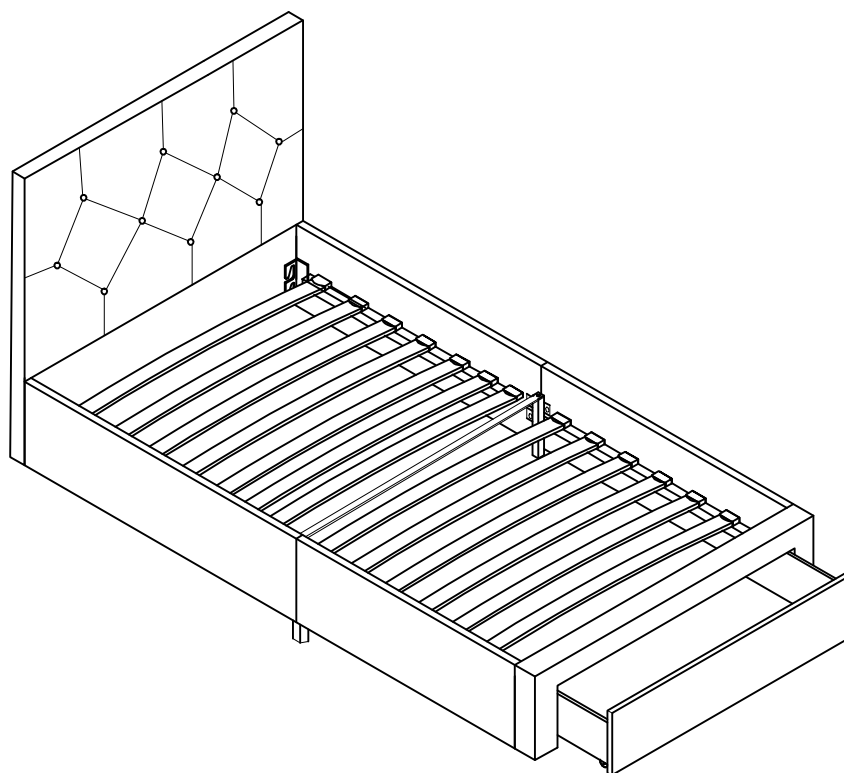

Notas Importantes

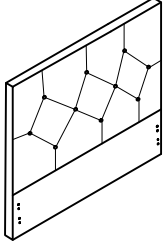
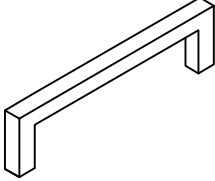
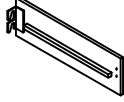
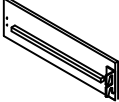
Coloque todas as peças numa superfície suave como uma carpete para evitar que alguma peça fique riscada

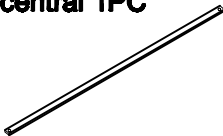
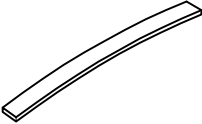

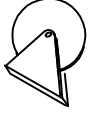

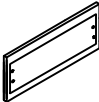
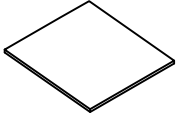

Antes de iniciar leia as instruções atentamente e siga-as passo a passo

Não aperte todos os parafusos até que a cama esteja completamente montada

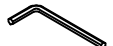

<p>① - Cabeceira 1PC</p> 	<p>② - Tábua frontal 1PC</p> 	<p>③ - Tábua laterais 2PCs</p> 
<p>④ - Tábua laterais 2PCs</p> 	<p>⑤ - Siderais Support legs(2pcs)</p> 	<p>⑥ Barra de suporte central 1PC</p> 
<p>⑦ -Tábuas de estrado 14PCs</p> 	<p>⑧ -Bracket (4pcs)</p> 	<p>⑨ -Legs (4pcs)</p> 
<p>⑩ -Capa plástica 28PCs</p> 	<p>⑪ -Drawer Side panel (2pcs)</p> 	<p>⑫-Drawer Back panel (1pc)</p> 
<p>⑬-Drawer Front panel (1pcs)</p> 	<p>⑭-Drawer Bottom panel (1pc)</p> 	

Identificação de peças

<p>A Parafuso M8*30mm 16pcs</p> 	<p>B Parafuso M8*20mm 24pcs</p> 	<p>C Anilhas de mola 16pcs</p> 	<p>D Anilhas 42pcs</p> 
<p>E Chave em L 1pc</p> 	<p>F Tapping screw M4*10mm 16pcs</p> 	<p>G Tapping screw M4*30mm 12pcs</p> 	

1º

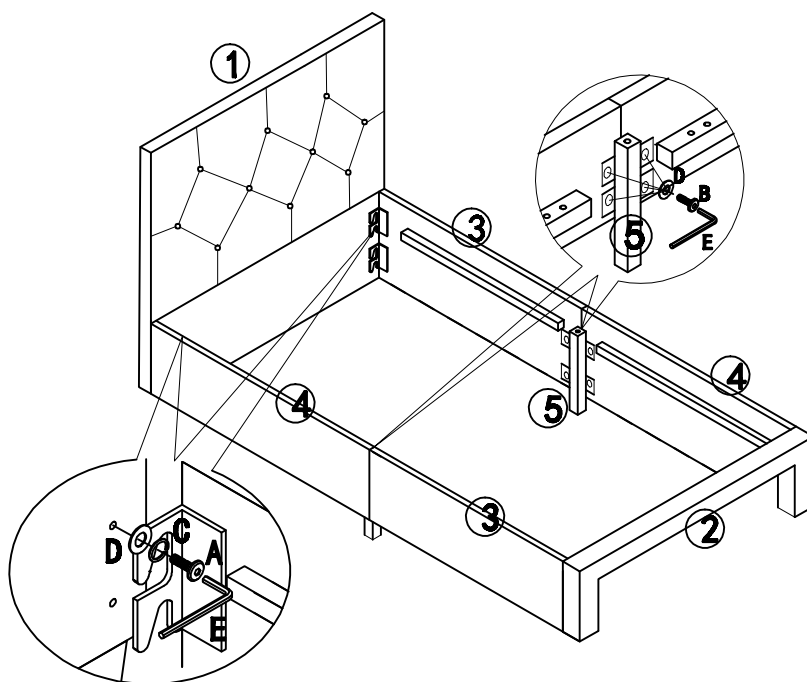

2°

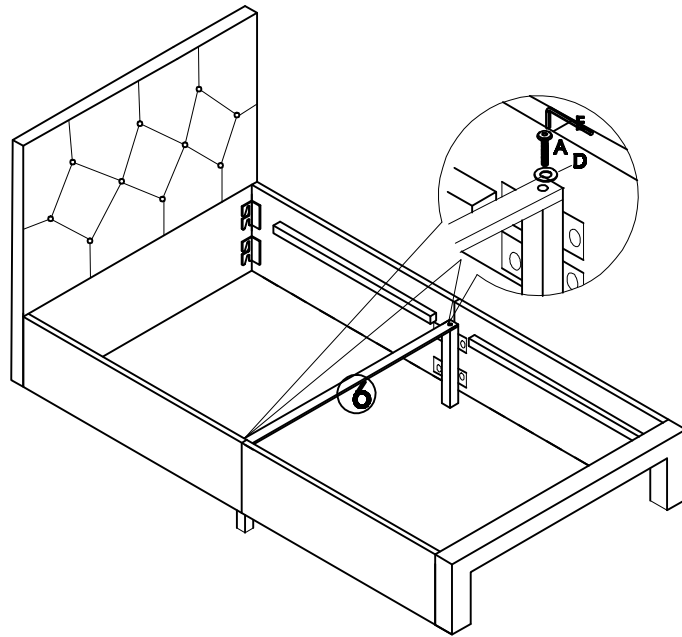

3°

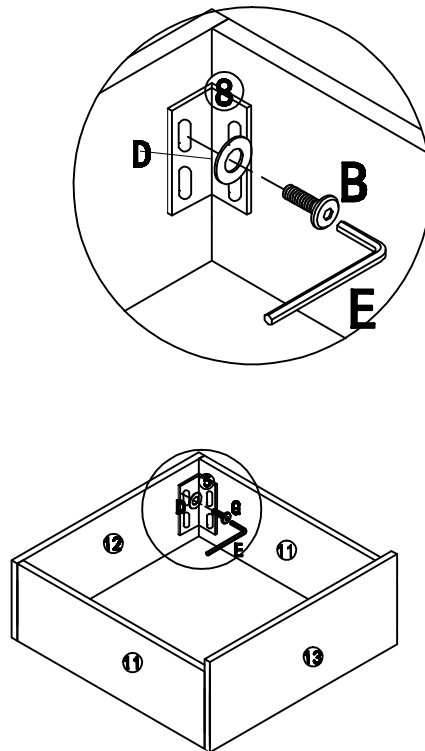

4°

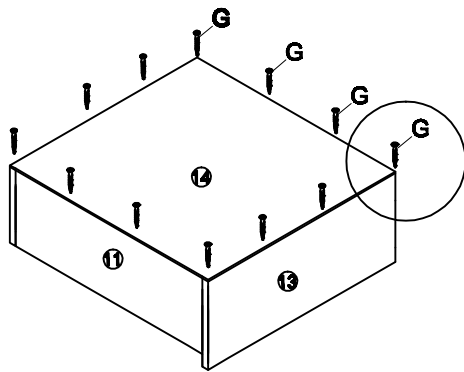
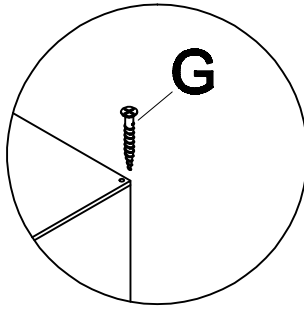

5°

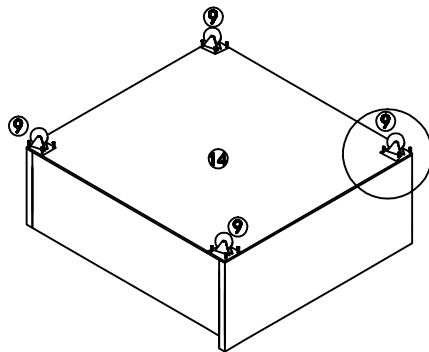
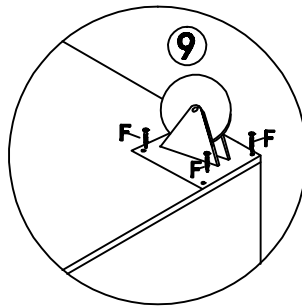

**6º Passo Fixar barra de suporte central
à cabeceira e à tábua frontal**

**Passo Fixar as capas de plástico
e as tábuas de estrado**

FIM

